

USER GUIDE

Versi 1.0

PUTRA[®] VIRTUAL IDENTIFICATION (PutraVID)

8 AUGUST 2018

By:

Pusat Pembangunan Maklumat dan Komunikasi (iDEC)
Universiti Putra Malaysia



Kandungan

INTRODUCTION	3
A. PUTRAVID APPLICATION (MOBILE VERSION)	4
1.0 DOWNLOAD PUTRAVID (MOBILE VERSION)	4
2.0 LOG IN ON PUTRAVID (VERSI MOBILE)	6
3.0 STAFF CARD / STUDENT MATRIC CARD DISPLAY.	7
3.0 QR CODE / BAR CODE DISPLAY.....	8
4.0 SCANNER USE.....	9
5.0 STAFF / STUDENT INFORMATION DISPLAY.....	10
6.0 FINGERPRINT REGISTRATION.	11
7.0 PRINT STAFF CARD / STUDENT MATRIC CARD.	12
8.0 CHANGE QR CODE.....	13
9.0 USE OF AUTO LOGOUT.....	14
B. PUTRAVID APPLICATION (WEB VERSION)	15
1.0 LOG IN ON PUTRAVID (WEB VERSION)	15
2.0 STAFF / STUDENT INFORMATION DISPLAY.....	16
3.0 QR CODE / BAR CODE DISPLAY.....	17
4.0 PRINT STAFF CAR / STUDENT MATRIC CARD.	18
5.0 CHANGE QR CODE.....	19

INTRODUCTION

Putra VID is an IDEC innovation to introduce student card staff card in the form of 'virtual' using 'QR Code' technology. There are several modules involved:

PutraVID's Application (Mobile Version)	
1.	Login of PutraVID (UPMID).
2.	Staff Card / Student Matric Card Display.
3.	QR Code / Bar Code Display.
4.	Scanner Use.
5.	Staff / Student Information Display.
6.	Fingerprint Registration.
7.	Print Staff Card / Student Matric Card.
8.	Change QR Code.
9.	Use of Auto Logout
PutraVID's Application (Web Version)	
1.	Login of PutraVID (UPMID).
2.	Staff Card / Student Matric Card Display.
3.	QR Code / Bar Code Display.
4.	Staff / Student Information Display.
5.	Print Staff Card / Student Matric Card.
6.	Change QR Code.

A. PUTRAVID APPLICATION (MOBILE VERSION)

1.0 DOWNLOAD PUTRAVID (MOBILE VERSION)

	<ol style="list-style-type: none">1. Click on Google Play if you're using an Android smartphone version 5.0 or higher.2. For this moment IOS smartphone is not available.
---	---

GOOGLE PLAY INSTALLATION

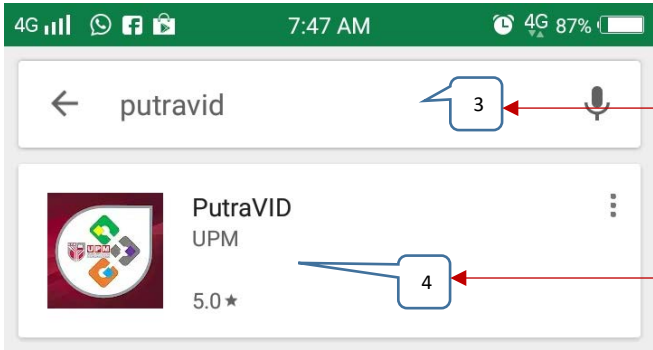
	<ol style="list-style-type: none">3. Enter the word 'putraavid'.4. Click the icon for installation purposes.
---	---



INSTALL

5



PutraVID – UPM's Virtual Identification

READ MORE

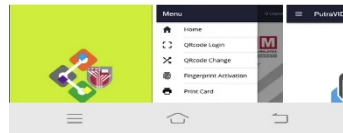

5. Click **INSTALL**.





6

6. Click the PutraVID icon located on the smartphone display.

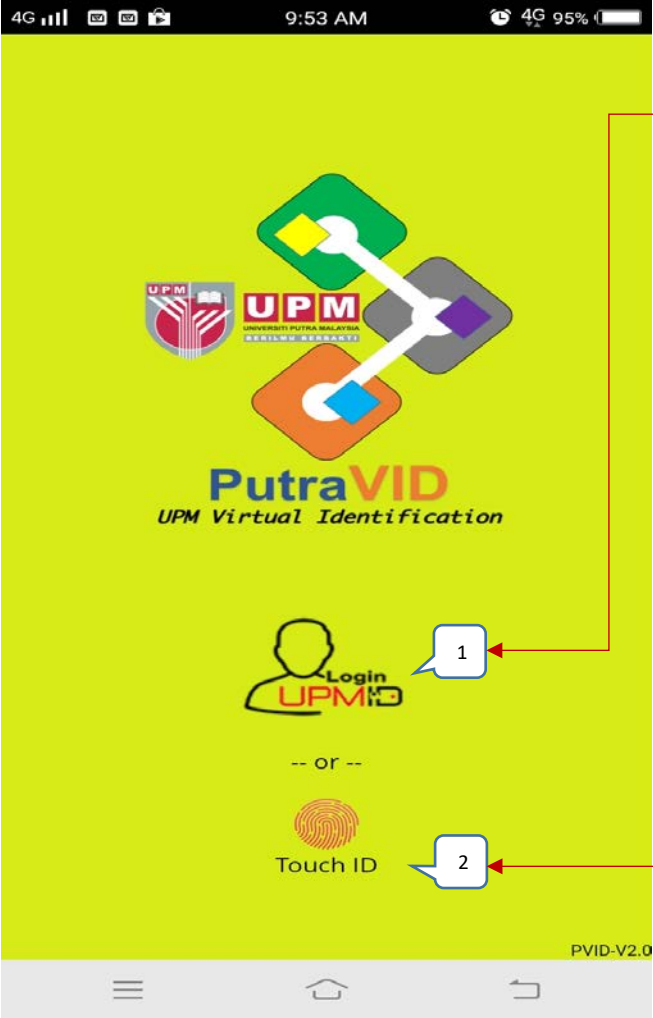
2.0 LOG IN ON PUTRAVID (VERSI MOBILE)



The screenshot shows the PutraVID mobile app interface. At the top, the status bar displays '4G', signal strength, time '9:53 AM', and battery level '95%'. The main screen has a yellow background with the UPM logo and 'PutraVID UPM Virtual Identification' text. Below this, there are two login options: a 'Login UPM ID' icon with a person silhouette and a 'Touch ID' icon with a fingerprint. Red arrows point from these icons to numbered callouts '1' and '2' respectively. At the bottom right, the version 'PVID-V2.0' is visible.

1. Click  icon to access PutraVID.
2. Click  icon if you want to access PutraVID through Fingerprint Recognition.

*** Note :**

- i. The  icon will only be displayed if the smartphone has fingerprint technology. Otherwise the icon is not displayed.
- ii. If user want to use the 'fingerprint' function, the user needs to enter PutraVID using the  icon first and register it on the 'Fingerprint Activation' menu.

3.0 STAFF CARD / STUDENT MATRIC CARD DISPLAY.

The screenshot shows the PutraVID mobile application interface. At the top, there is a status bar with 4G signal, 9:53 AM, and 95% battery. Below the status bar is a dark blue header with a menu icon (callout 2), the text 'PutraVID', and a 'Logout' button (callout 3). The main content area features the UPM logo and the text 'UPM UNIVERSITI PUTRA MALAYSIA BERILMU BERBAKTI'. Below this is a large red-bordered box containing a staff card for 'STAF' (callout 1). The card includes a photo of a man, the name 'ROSTAM BIN ABU BAKAR', and the matric number 'A02812'. At the bottom of the screen, there is a 'Verify' button (callout 4) and a bottom navigation bar with a home indicator (callout 5) and a back indicator (callout 6).



1. Display of Staff Card (for UPM Staff) / Student Card (for UPM Students) as follows:
 - a. Picture
 - b. Name.
 - c. Staff Number / Student Matric Number.
2. The menus of PutraVID consist of Home, QR Code Login, Print Card, QR Code Change, 'Fingerprint Activation', Setting, About, and; Log out.
3. Log Out icon.
4. Icon that will display Staff Card (for UPM Staff) / Student Card (for UPM Students).
5. Verify icon to enable PutraVID scanner.
6. Icons featuring QR Code, Bar Code, and staff / student information.

3.0 QR CODE / BAR CODE DISPLAY.

The screenshot displays the PutraVID mobile application interface. At the top, the status bar shows 4G signal, 9:53 AM, and 95% battery. The app header includes a menu icon, the text 'PutraVID', a home icon, and a 'Logout' button. The main content area features a large QR code (callout 1), a callout 2 pointing to the QR code area, a staff information card for 'ROSTAM BIN ABU BAKAR' (callout 2), a barcode with the number '300000 xxxx' (callout 3), and a 'Verify' button with a barcode icon (callout 5). The bottom navigation bar contains a menu icon (callout 4), a home icon, and a back icon (callout 6).

1. QR Code.
2. Staff / student information.
3. Bar Code include Patron ID.
4. Icon that will display Staff Card (for UPM Staff) / Student Card (for UPM Students).
5. Verify icon to enable PutraVID scanner.
6. Icons featuring QR Code, Bar Code, and staff / student information.

4.0 SCANNER USE.

1. Untuk To activate the scanner, click the  Verify icon on the staff / student card view or click on the menu and click on the  QR Code Login icon

2. Click [Scan Code] icon.

3. Point the square space to the QR Code to scan.

5.0 STAFF / STUDENT INFORMATION DISPLAY.



The screenshot shows the PutraVID Verify/Scan app interface. At the top, the status bar displays 4G, signal strength, 9:55 AM, and 95% battery. The app header includes a menu icon, the title 'PutraVID Verify/Sc...', a home icon, and a 'Logout' button. The main content area shows a 'Result from Scan:' section with a red dashed border. Inside this section, it says 'PutraVID Verification' above a photo of a man. Below the photo, the name 'ROSTAM BIN ABU BAKAR' and ID 'A02812' are displayed, followed by the job title 'PEGAWAI TEKNOLOGI MAKLUMAT' and department 'PUSAT PEMBANGUNAN MAKLUMAT DAN KOMUNIKASI'. A callout box with the number '1' points to the photo. At the bottom, there is a 'SCAN CODE' button with a QR icon, a 'Verify' button with a barcode icon, and a bottom navigation bar with menu, home, and back icons.

Next ,

1. Staff / student information will be displayed if the scanned QR Code is valid. Otherwise, the 'No Result Found' message will be displayed.



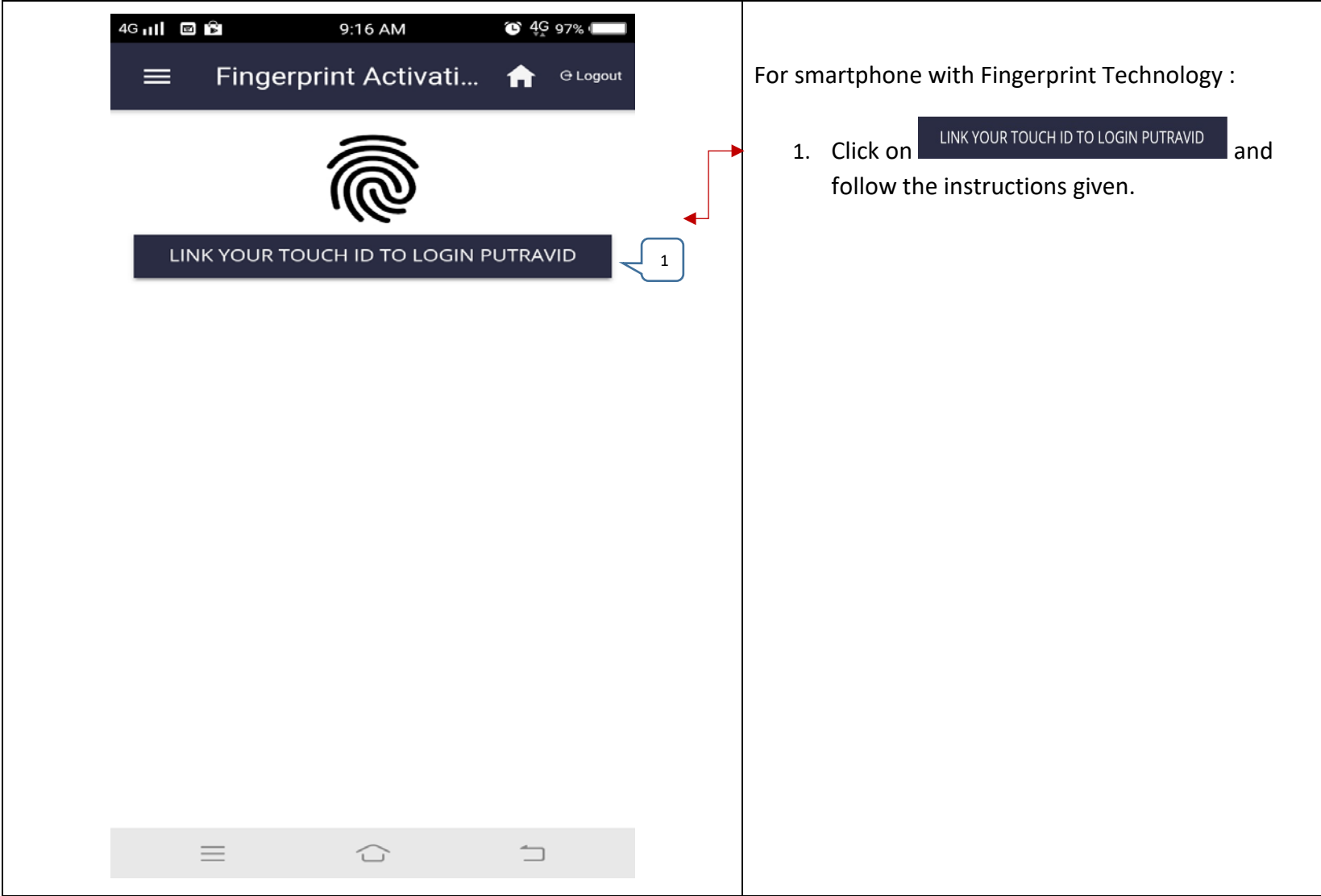

6.0 FINGERPRINT REGISTRATION.

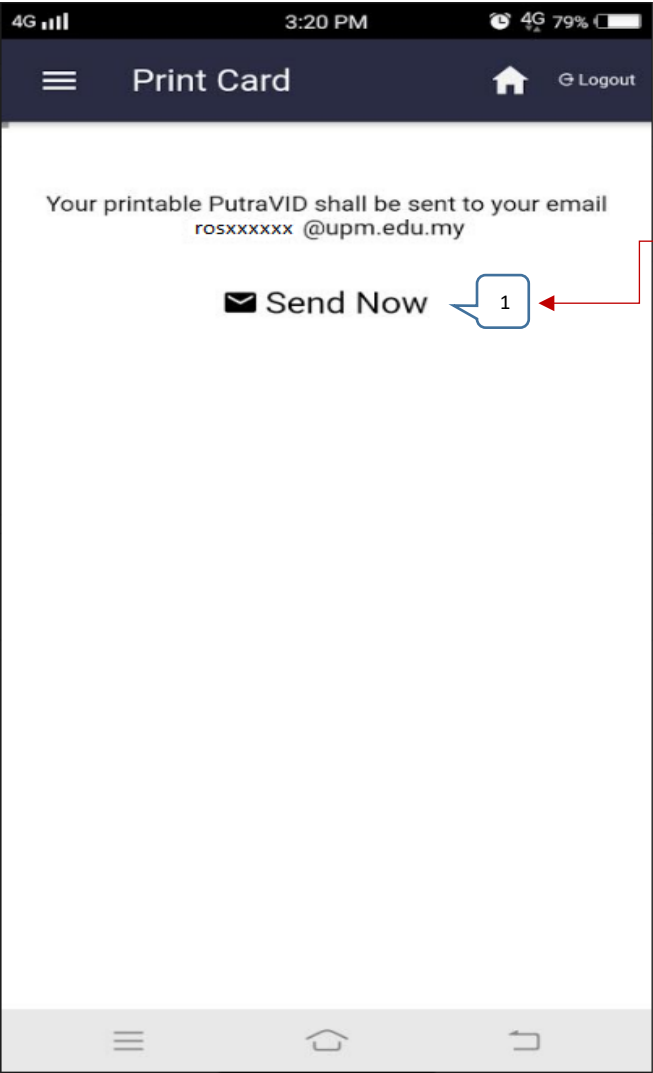

For smartphone with Fingerprint Technology :

1. Click on **LINK YOUR TOUCH ID TO LOGIN PUTRAVID** and follow the instructions given.

7.0 PRINT STAFF CARD / STUDENT MATRIC CARD.



	<p>For print purposes, click  icon and select  Print Card .</p> <ol style="list-style-type: none">1. Click  Send Now icon. Virtual card has been sent via user email.
---	--

8.0 CHANGE QR CODE.



The screenshot shows a mobile application interface for changing a QR code. At the top, the status bar displays '4G', signal strength, time '9:55 AM', and battery level '95%'. The app header is dark blue with a hamburger menu icon on the left, the title 'QR Code Change' in the center, and a home icon and 'Logout' link on the right. The main content area features a large QR code, a text input field labeled 'UPM-ID Password', and a dark blue button labeled 'RESET QR'. Three numbered callouts are present: '1' points to the hamburger menu icon, '2' points to the QR code, and '3' points to the 'RESET QR' button. Red arrows originate from the callouts and point to the corresponding elements in the instructions on the right.



For security purposes, QR Code can be changed :

1. Click  icon and then click  QRcode Change icon.
2. Enter the UPMID password.
3. Click  icon to change QR Code.

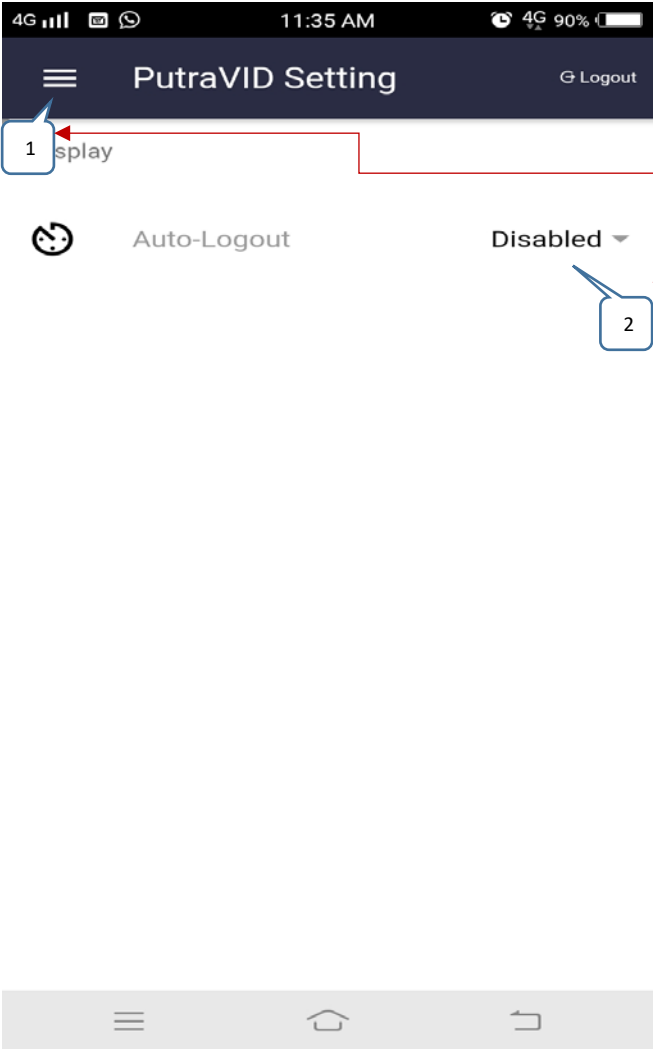
9.0 USE OF AUTO LOGOUT.



The screenshot shows the PutraVID Setting app interface. At the top, there is a status bar with 4G signal, 11:35 AM, and 90% battery. Below the status bar is a dark header with a menu icon, the text "PutraVID Setting", and a "Logout" button. A callout box labeled "1" points to the menu icon. Below the header, there is an "Auto-Logout" section with a clock icon and the text "Auto-Logout". To the right of this section, the status "Disabled" is shown with a dropdown arrow. A callout box labeled "2" points to the "Disabled" text. At the bottom of the screen, there is a navigation bar with three icons: a menu icon, a home icon, and a back icon.



1. Click  icon and then click  Setting icon.
2. Click and select the option at the time on the right. Click OK if if you've made an option.

B. PUTRAVID APPLICATION (WEB VERSION)

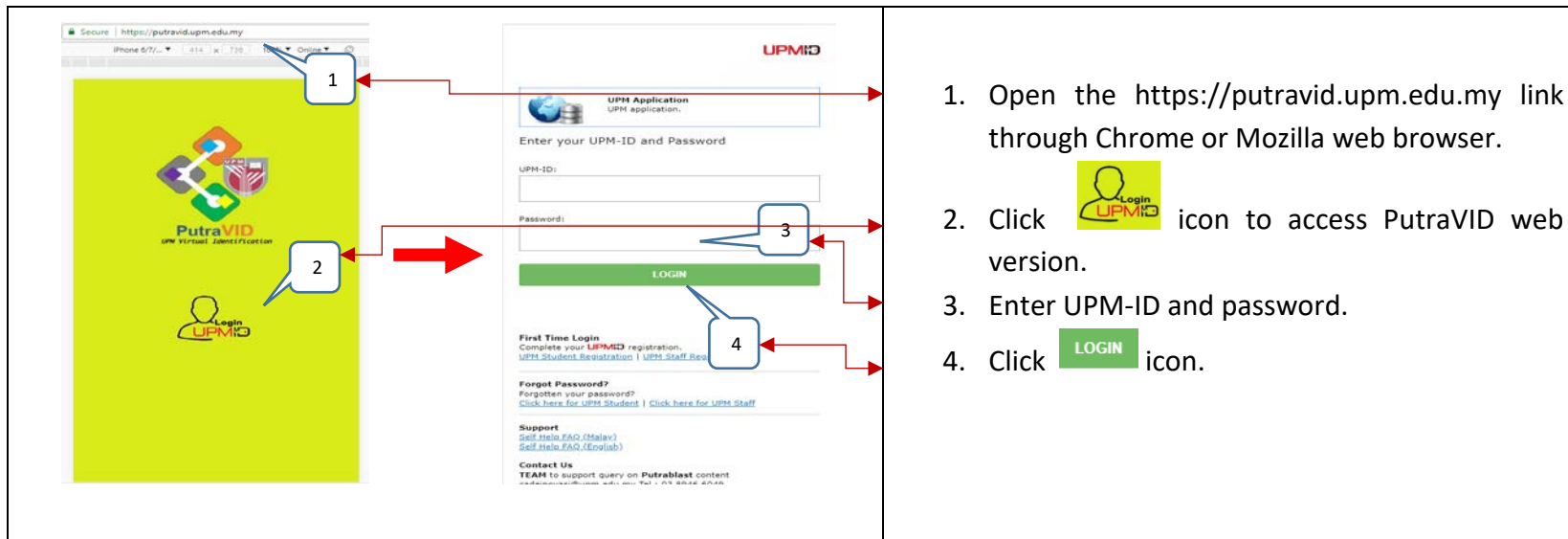
1.0 LOG IN ON PUTRAVID (WEB VERSION)



The image shows a browser window displaying the PutraVID login page. The page has a yellow background with the PutraVID logo and a 'Login UPM-ID' icon. A red arrow points from the icon to the 'UPM Application' section of the login form. The form contains fields for 'UPM-ID' and 'Password', and a green 'LOGIN' button. Below the form are links for 'First Time Login', 'Forgot Password?', and 'Support'. The page is annotated with four numbered callouts: 1 points to the browser address bar, 2 points to the 'Login UPM-ID' icon, 3 points to the 'Password' field, and 4 points to the 'LOGIN' button. To the right of the screenshot is a list of four numbered instructions corresponding to these callouts.

1. Open the <https://putravid.upm.edu.my> link through Chrome or Mozilla web browser.
2. Click  icon to access PutraVID web version.
3. Enter UPM-ID and password.
4. Click  icon.

2.0 STAFF / STUDENT INFORMATION DISPLAY.

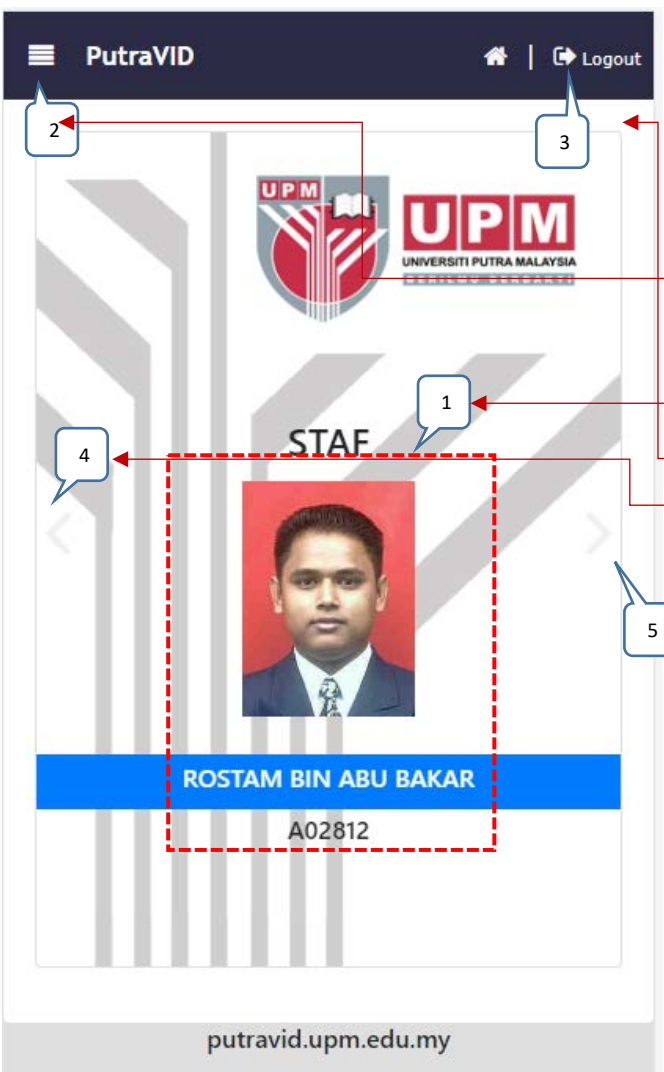

The screenshot displays the PutraVID mobile application interface. At the top, there is a dark header with the text "PutraVID" on the left and a "Logout" button on the right. Below the header, the UPM logo is prominently displayed. The main content area features a large "STAF" label above a photo of a staff member. Below the photo, a blue bar contains the name "ROSTAM BIN ABU BAKAR" and the ID number "A02812". At the bottom of the screen, the URL "putraavid.upm.edu.my" is visible. Five numbered callouts (1-5) are placed around the interface, with red arrows pointing to specific UI elements: 1 points to the staff card area, 2 points to the menu icon, 3 points to the Logout icon, 4 points to the photo, and 5 points to the QR code area.

1. Display of Staff Card (for UPM Staff) / Student Card (for UPM Students) as follows:
 - a. Picture
 - b. Name.
 - c. Staff Number / Student Matric Number.
2. The menus of PutraVID consist of Home, QR Code Login, Print Card, QR Code Change, 'Fingerprint Activation', Setting, About, and; Log out.
3. Log Out icon.
4. Icon that will display Staff Card (for UPM Staff) / Student Card (for UPM Students).
5. Icons featuring QR Code, Bar Code, and staff / student information.

3.0 QR CODE / BAR CODE DISPLAY.

The image shows a mobile application interface for PutraVID. At the top, there is a dark blue header with the text "PutraVID" and a "Logout" button. Below the header is a large QR code. To the right of the QR code is a callout box labeled "1". Below the QR code is a staff information card with a red dashed border. The card contains the name "ROSTAM BIN ABU BAKAR", a placeholder "XXXXXXXXXXXX", and the title "PEGAWAI TEKNOLOGI MAKLUMAT". To the right of this card is a callout box labeled "2". Below the staff information card is a barcode with the number "300000XXXX" below it. To the right of the barcode is a callout box labeled "3". To the left of the QR code is a callout box labeled "4". To the right of the QR code and staff information card is a callout box labeled "5". At the bottom of the screen, there is a grey footer with the URL "putraavid.upm.edu.my".

1. QR Code.
2. Staff / student information.
3. Bar Code include Patron ID.
4. Icon that will display Staff Card (for UPM Staff) / Student Card (for UPM Students).
5. Icons featuring QR Code, Bar Code, and staff / student information.

4.0 PRINT STAFF CAR / STUDENT MATRIC CARD.





Success! Pdf sent to rostamab@upm.edu.my

UPM
UNIVERSITI PUTRA MALAYSIA
BERILMU BERSAKTI

STAF

ROSTAM BIN ABU BAKAR
A02812

putraVID.upm.edu.my

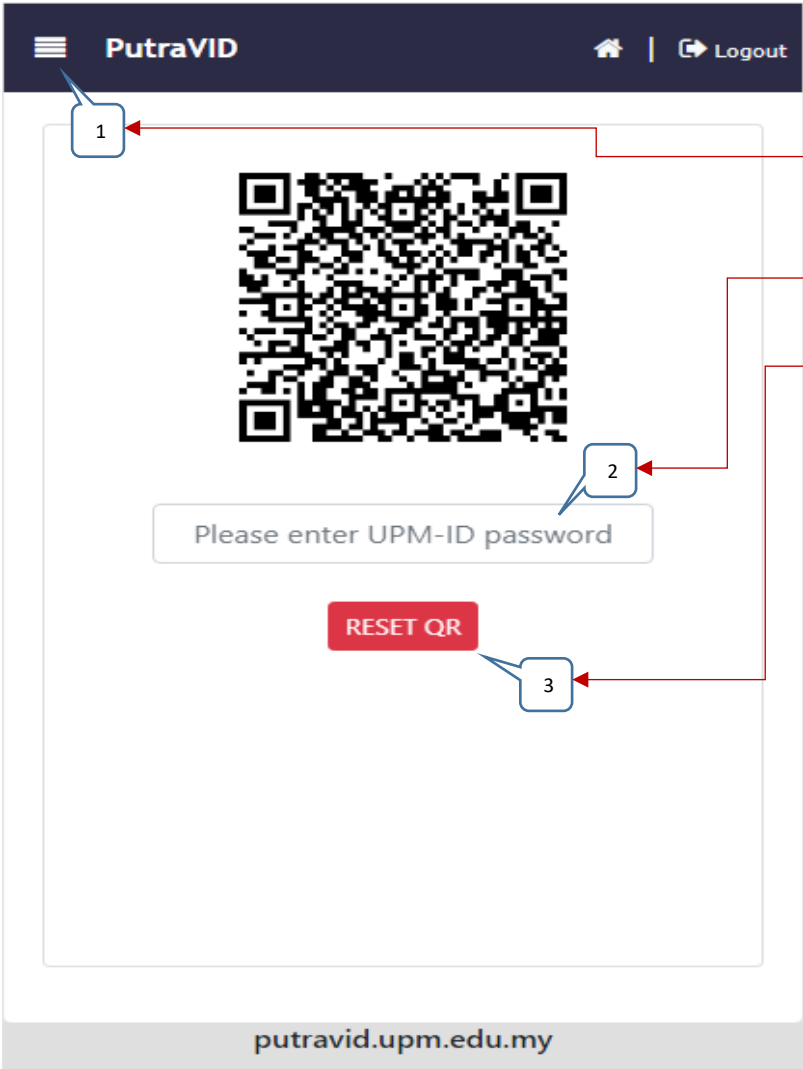

1. Click icon  and then click  Print Card icon.
2. Virtual cards will be sent to the email.

5.0 CHANGE QR CODE.



The screenshot shows the PutraVID web interface. At the top, there is a dark blue header with the PutraVID logo and a 'Logout' button. The main content area features a large QR code. Below the QR code is a text input field with the placeholder text 'Please enter UPM-ID password'. A red button labeled 'RESET QR' is positioned below the input field. Three numbered callouts (1, 2, and 3) are connected to the interface by red arrows. Callout 1 points to the menu icon in the top left. Callout 2 points to the password input field. Callout 3 points to the 'RESET QR' button. The URL 'putraavid.upm.edu.my' is visible at the bottom of the page.

For security purposes, QR Code can be changed :

1. Click  icon and then click  QR Code Change icon.
2. Enter the UPMID password.

Click  icon to change QR Code.